

# CADRE

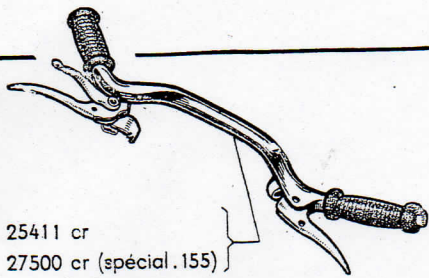

25411 cr  
27500 cr (spécial .155)  
27616

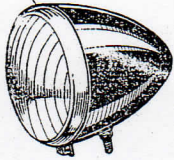

28076 E  
26928 D.G

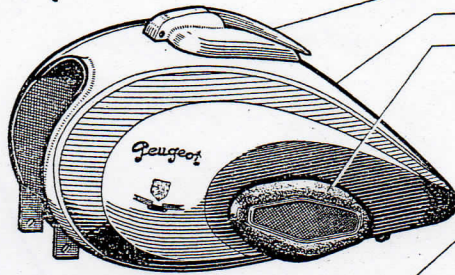

26676  
28879 E bis  
28130

28927 E

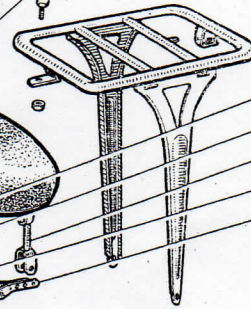

26290 E  
23479 E  
23481  
26277 E  
27472  
27471  
24630

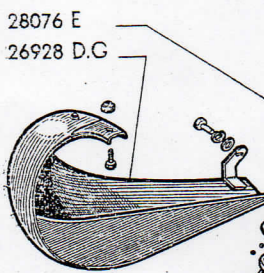

7555  
28498 E  
17990  
25959 E  
26201 E  
26026 E  
26418  
26663 D.G  
17658

7570  
23480  
2166

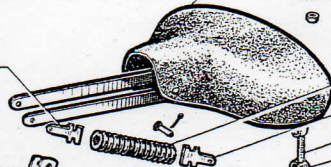

25880 E

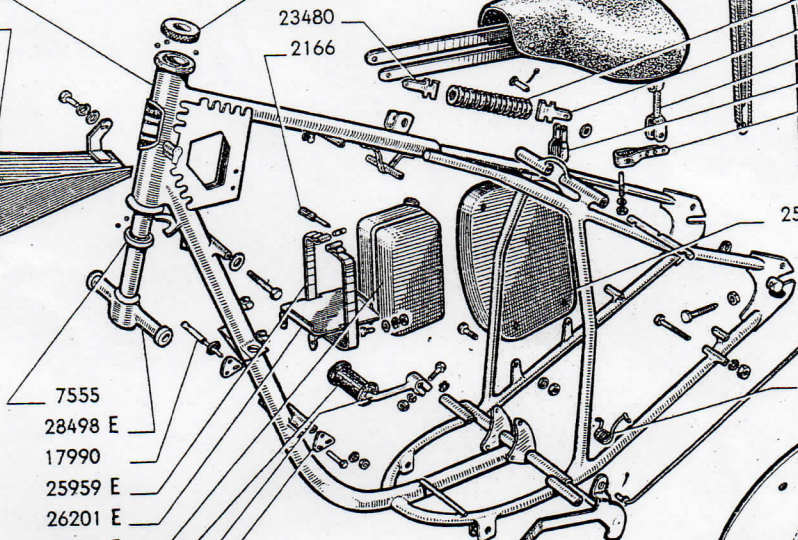

24631  
2268  
26730

26275

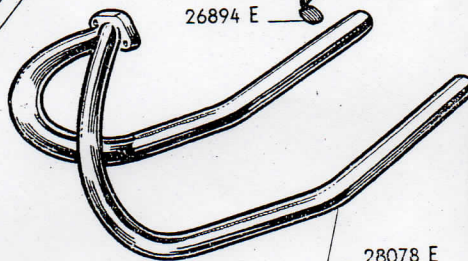

26894 E

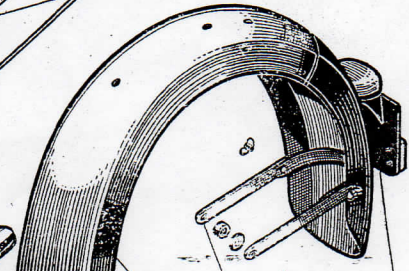

25782  
26493  
26490 E  
26238 E

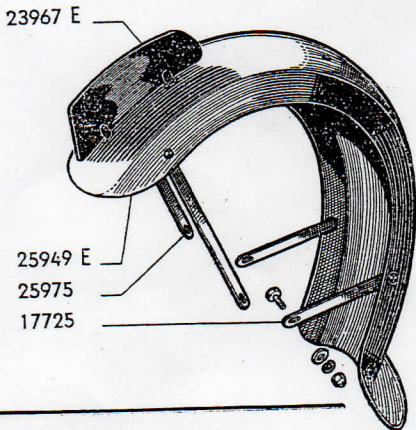

23967 E  
25949 E  
25975  
17725

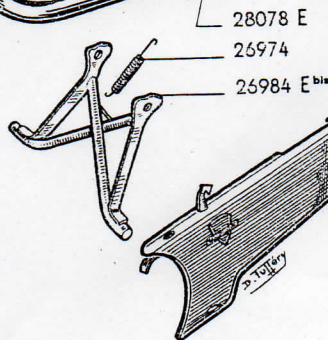

28078 E  
26974  
26984 E bis